

Specifications

Nominal Voltage		12 V
Capacity (25°C)	10HR(10.8V)	28.0 Ah
	5HR(10.5V)	25.9Ah
	1HR(9.60V)	19.2 Ah
Dimension	Length	166 ± 2mm (6.54inch)
	Width	175 ± 2mm (6.89inch)
	Height	125 ± 2mm (4.92inch)
	Total Height	125 ± 2mm (4.92inch)
Approx. Weight		8.7kg (19.2lbs) ± 4%
Terminal type		T3/T8
Internal resistance (Fully charged, 25°C)		Approx. 10mΩ
Capacity affected by temperature (20HR)	40°C	102%
	25°C	100%
	0°C	85%
	-15°C	65%
Self-discharge (25°C)	3 month	Remaining Capacity: 91%
	6 month	Remaining Capacity: 82%
	12 month	Remaining Capacity: 65%
Nominal operating temperature		25°C ± 3°C (77°F ± 5°F)
Operating temperature range	Discharge	-15°C ~ 50°C (5°F ~ 122°F)
	Charge	-10°C ~ 50°C (14°F ~ 122°F)
	Storage	-20°C ~ 50°C (-4°F ~ 122°F)
Float charging voltage(25°C)		13.60 to 13.80V Temperature compensation: -18mV/°C
Cyclic charging voltage(25°C)		14.50 to 14.90V Temperature compensation: -30mV/°C
Maximum charging current		8.4A
Terminal material		Copper
Maximum discharge current		420A(5 sec.)
Designed floating life(20°C)		15 years

Dimensions

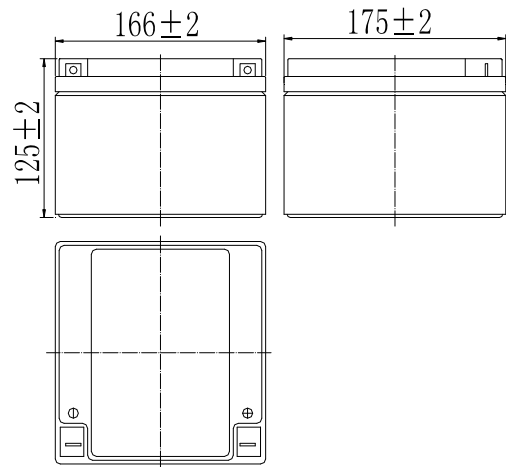

Terminal

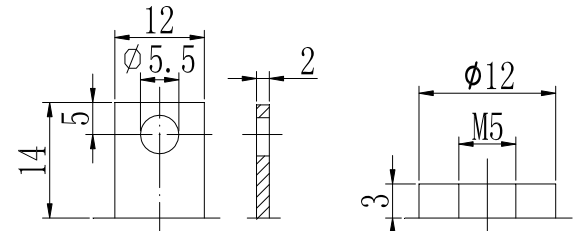

Terminal T3

Terminal T8

- ◆ Absorbent glass mat technology;
- ◆ Recognized by UL & CE;
- ◆ ABS container.

Constant Current Discharge Characteristics (A, 25°C)

F.V/TIME	10min	15min	30min	60min	2h	3h	4h	5h	8h	10h	20h
9.60V	69.8	55.9	31.2	19.2	10.9	7.79	6.23	5.30	3.43	2.88	1.49
9.90V	67.7	54.5	30.5	18.9	10.8	7.75	6.20	5.27	3.40	2.87	1.49
10.2V	64.9	52.5	29.6	18.3	10.7	7.69	6.15	5.23	3.38	2.86	1.48
10.5V	62.2	50.7	28.9	18.0	10.5	7.64	6.11	5.19	3.36	2.84	1.47
10.8V	58.7	48.0	27.8	17.5	10.3	7.41	5.92	5.04	3.26	2.80	1.44

Constant Power Discharge Characteristics (Watt, 25°C)

F.V/TIME	10min	15min	30min	60min	2h	3h	4h	5h	8h	10h	20h
9.60V	788	637	357	221	127	92.5	74.2	63.3	41.1	34.6	17.9
9.90V	764	622	350	218	127	92.0	73.7	62.8	40.9	34.5	17.8
10.2V	733	599	339	213	125	91.3	73.3	62.4	40.6	34.3	17.7
10.5V	701	578	331	208	123	90.8	72.8	62.0	40.4	34.0	17.6
10.8V	662	548	319	202	120	88.0	70.6	60.1	39.2	33.4	17.3

Note: The above characteristics data can be obtained within three charge/discharge cycles.

Discharge Characteristics(25°C)

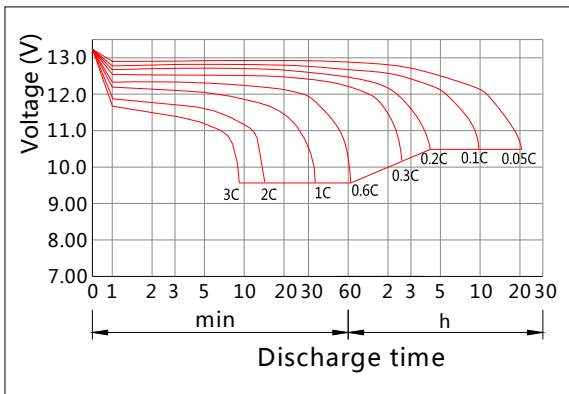

Charging Characteristics(25°C)

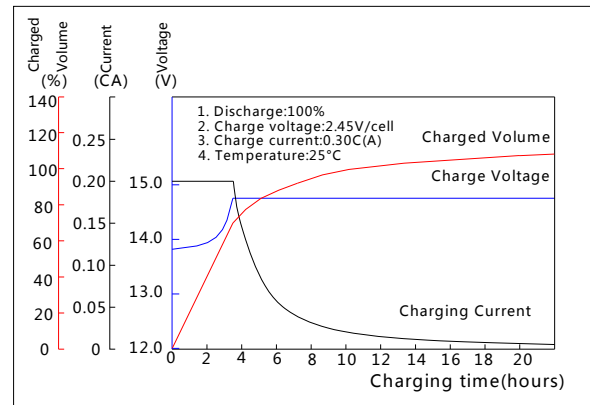

Effect of Temperature on Capacity

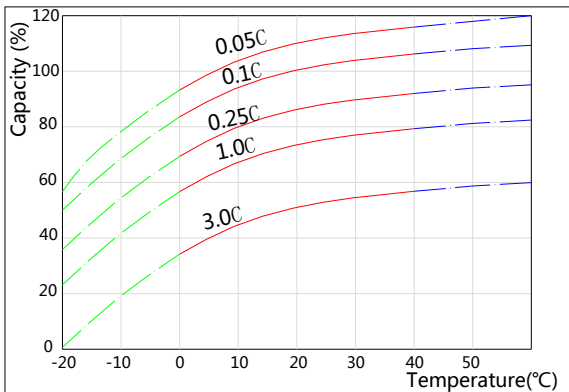

Self-discharge Characteristics

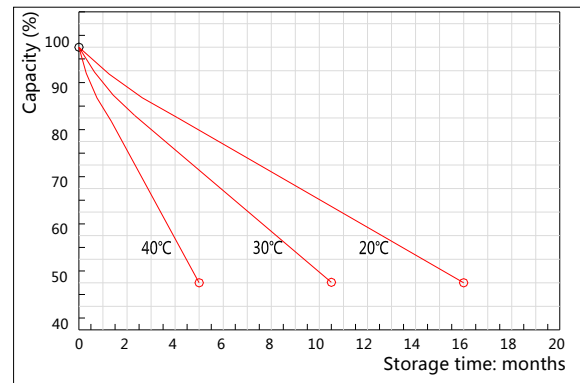

The Relationship for Open Circuit Voltage and Residual Capacity (25°C)

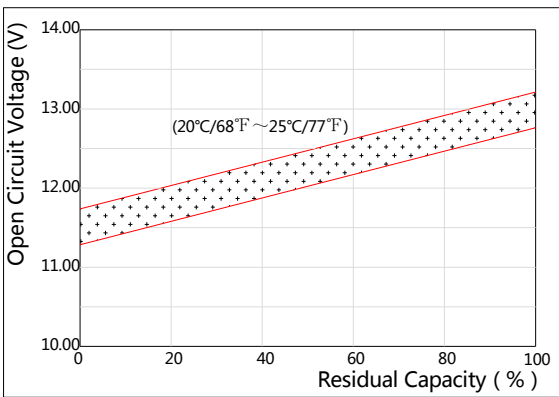

The Relationship for Charging Voltage and Temperature

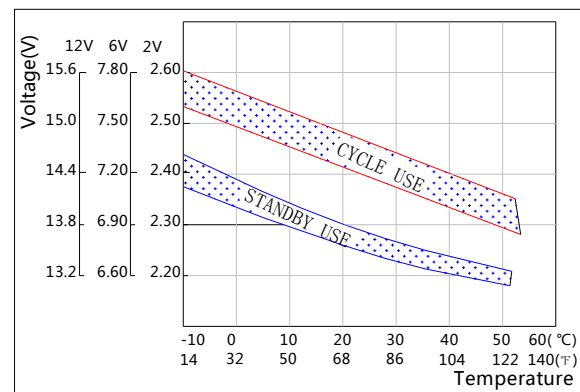

Floating Life on Temperature

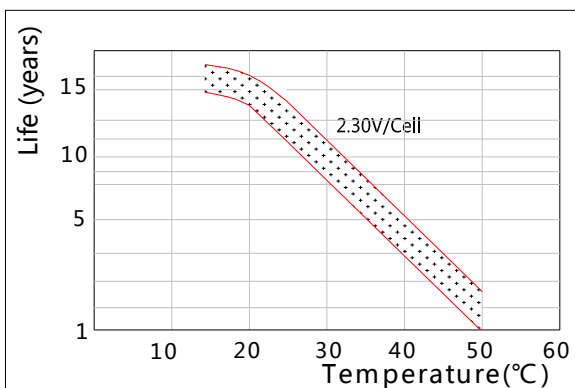

Cycle Life on D.O.D(25°C)

